

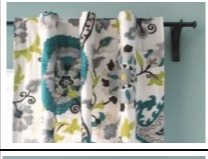









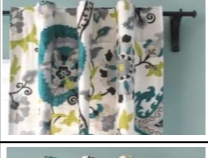

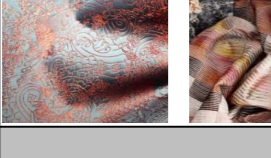
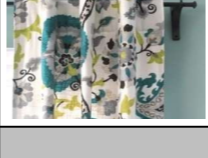
Detailed Specifications																		
Vice Chancellor' Bungalow- Details of Door and Window Furnishings																		
		Reference Image	Width	Material blend	Shade	Material Design	Thickness gsm	Stitching Type	Curtain' Front (Ref Image)	Curtain' Back (Ref Image)	Curtain' Bottom (Ref Image)	Qty required in mtrs	Window/ Door	No of Windows or Door	Dimensions in Feet	Wall coverage sft	Rate per mtr	Total with GST
Fabric	Type A Curtain		48"	70% Polyester and 30% Cotton	Beige and Blue	Printed, Cotton or Linen Finish	200gsm	Fabric Loops behind the curtain using the same material				25	W4	2	8' x 6'5"	122sft		
Fabric	Type B Curtain		48"	70% Polyester and 30% Cotton	Light Blue and Green	Printed	320gsm	Fabric Loops behind the curtain using the same material				47	W3 W W5	3 2 1	6' x 4'6" 3' x 4'6" 10' x 6'6"	151sft 50sft 72sft		
Fabric	Type C Curtain		54"	100% Polyester Filament	Cream and Light green	Thread work, Silk finish	280gsm	Fabric Loops behind the curtain using the same material				31	W4 W2	2 1	8' x 6'6" 5' x 4'6"	130sft 40sft		
Fabric	Type D Curtain		48"-54"	100% Polyester Filament	Warm shades of Red and Peach. Preferably silk finish.	Thread work / Print, Silk finish	280gsm - 320gsm	Fabric Loops behind the curtain using the same material				33	W4 W W2	1 2 2	8' x 6'6" 3' x 4'6" 5' x 4'6"	64sft 57sft 72sft		
Roman Blind	Type E Curtain		54"	100% Polyester Filament	Beige and White	Embroidered, Cotton or Linen finish	280gsm	Roman Blind				20	W2 CW	1 2	5' x 4'6" 5' x 4'6"	22sft 44sft		
Sheer	Type F Curtain		48"	100% Polyester	Cream	Weaving Patterns	150-200gsm	Fabric Loop for the rod to go through.				60	W4 W6 FD ED	2 1 1 1	8' x 6'6" 2' x 6'6" 10'2" x 7' 8'6" x 7'	122 22 74 70		
Sheer	Type G Curtain		48"	100% Polyester	Cream	Weaving Patterns	150-200gsm	Fabric Loop for the rod to go through.				103	W3 W W5 W4 W2	3 2 1 3 3	6' x 4'6" 3' x 4'6" 10' x 6'6" 8' x 6'6" 5' x 4'6"	151sft 52sft 72sft 195sft 120sft		
Sheer	Type H Curtain		48"	100% Polyester	Cream	Weaving Patterns	150-200gsm	Fabric Loop for the rod to go through.				44	W4 W2 FD1 MasterBedroom Door	1 1 1 1	8' x 6'6" 5' x 4'6" 12' x 7' 3' x 7'	65sft 43sft 94sft 22sft		
Sheer	Type I Curtain		48"	100% Polyester	Cream	Weaving Patterns	150-200gsm	Fabric Loop for the rod to go through.				33	W4 W W2	1 2 2	8' x 6'6" 3' x 4'6" 5' x 4'6"	64sft 58sft 72sft		

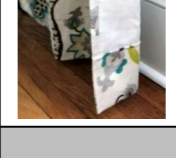
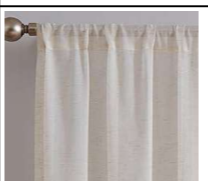
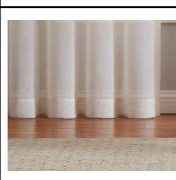
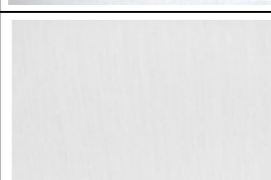
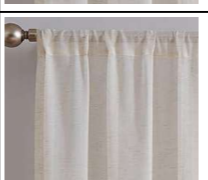
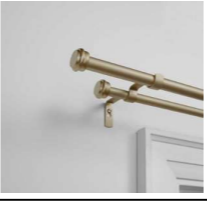
								<b>Sub Total</b>				<b>396</b>				<b>2120</b>		
W CW FD ED	Window Corner Window French Door Entrance Door															<b>Rate per Running feet</b>	<b>Total with GST</b>	
<b>Curtain Rod Length</b>	Overall Length								Normal Steel rod, powder coated finishes				360 Running Feet					